

TPS (HDBaseT™) extender for DisplayPort with local monitor out

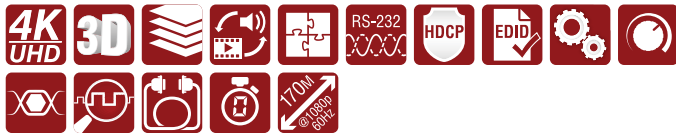

Part No: 9154 0018



Highlight features

- 4K and UHD video
- Extends DisplayPort1.1 + Audio + Ethernet + RS-232 + IR + GPIO over a single CAT5e...CAT7e cable up to 170 m distance*
- Event Manager
- 10/100 Ethernet extension
- Bi-directional RS-232 and IR
- GPIO control port
- Embeds analog audio

*Depends on cable category and quality

The DP-TPS-TX220 is the high end part of Lightware's TPS (HDBaseT Transmitter) product family. The device is an all-round video, audio and control transmitter over a single CAT cable up to 170 meter distance for ever-changing environments such as small board rooms and classrooms. The extender was designed to handle DP1.1 digital video signals and analog stereo audio from local inputs or DP embedded audio up to 8 Channel PCM or HBR audio. Analog audio is converted to a digital format. The device has a local video output. The video and the embedded audio of the local output is the same as transmitted via TPS link.

The DP-TPS-TX220 handles HDCP encryption. Using the factory, custom or transparent EDID emulation the user can fix and lock EDID data on each input connector. Advanced EDID Management forces the required resolution from any video source and fixes the output format to conform to the system requirements. The unit offers bi-directional and transparent IR, RS232 and Ethernet transmission. Furthermore the RS232 and IR connection supports command injection. Remote powering is available through the single CAT 5e ... CAT 7 cable, but a local power supply can also be used. All devices can be mounted on a rack shelf or used in standalone formats. Due to Lightware's attentive design the DP-TPS-TX 220 is compatible with both the HDBaseT extenders and matrix switchers.

HDBaseT™ and the HDBaseT Alliance logo are trademarks of the HDBaseT Alliance

DP-TPS-TX220

Standalone application

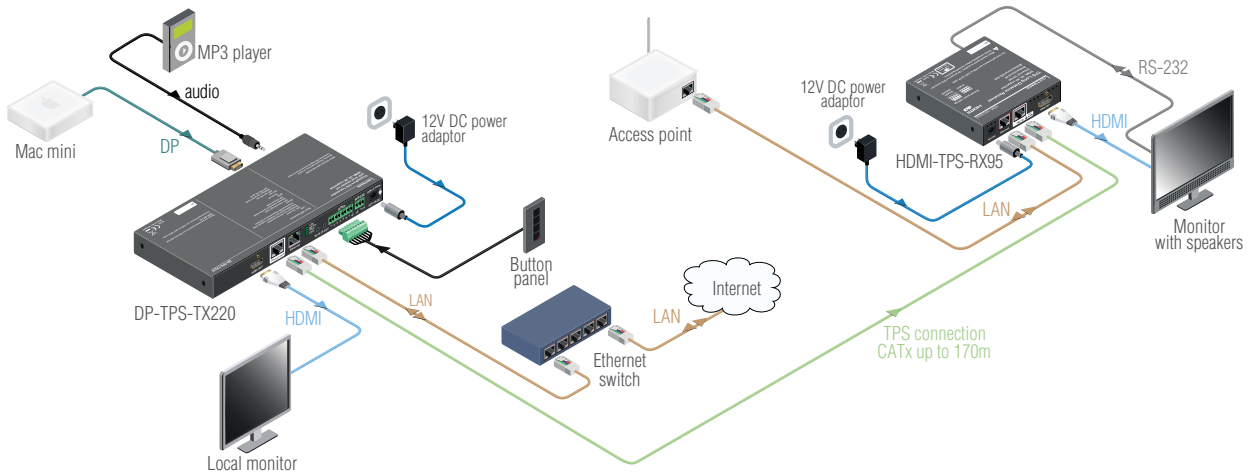

Application diagram

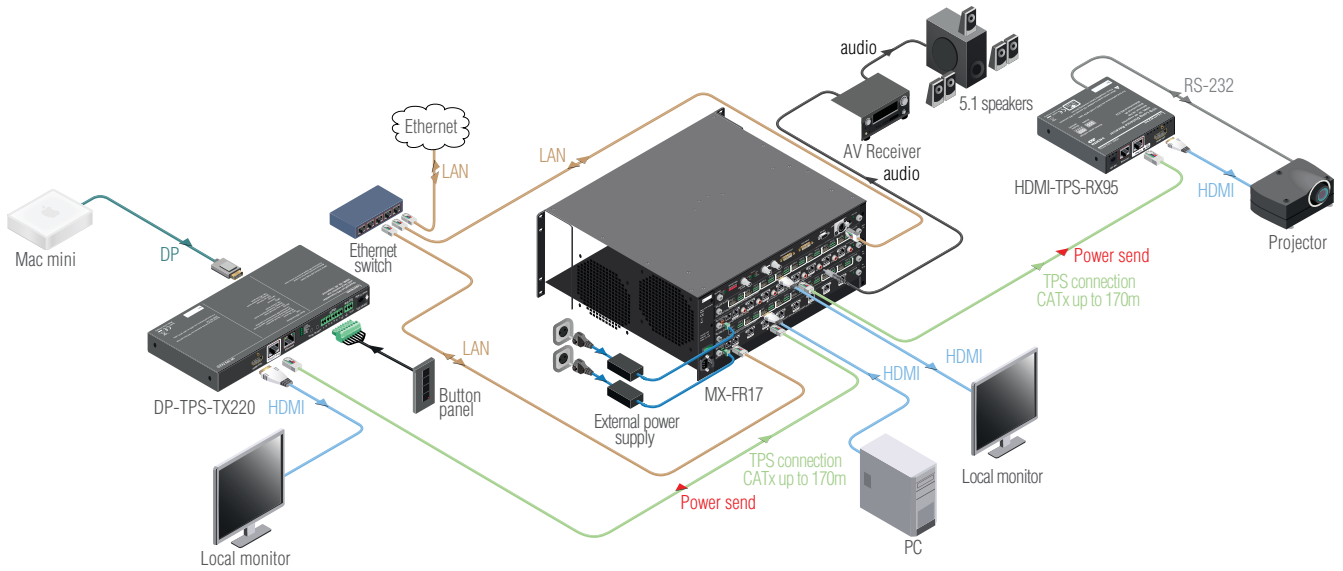

Transmitter front and back view



DP-TPS-TX220

Event Manager

The Event Manager is a completely new feature of Lightware's UMX-TPS extender family. It's available through the Lightware Device Controller and can be configured to detect LW3 protocol CHANGE messages. The Event Manager was developed to handle tasks from the most simple; like displaying internal events on GPIO ports, and controlling the extender via GPIO inputs instead of front panel pushbuttons; to expert ones like controlling the rolling shutter, the air conditioning system or the lights based on any condition changes on the media ports, such as a new source being connected or removed. The Event Manager makes the UMX-TPS extender family an expert solution in a wider range of applications.

Event Manager Wizard

Assigning an action to a condition is quick and easy with the Event manager's smart Wizard function. The user can choose from the given port options in the dropdown menu and also add expressions to it.



The Events menu contains 20 separately configurable Events

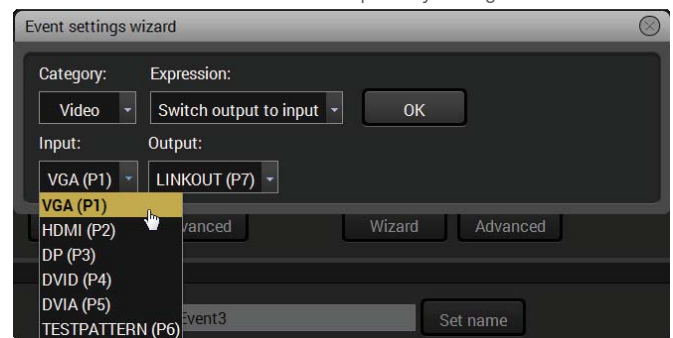

The Event Wizard makes the setup easy with simple dropdown options

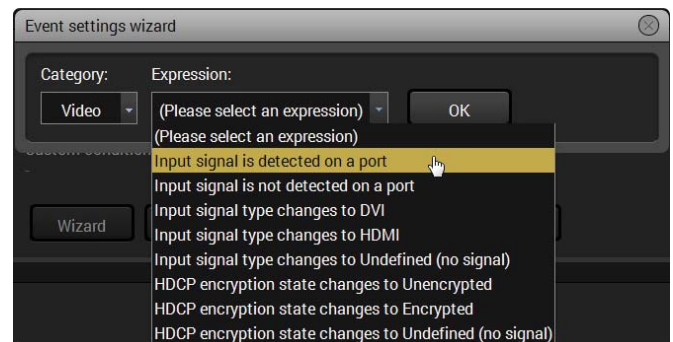

There are many default Expression available to choose from

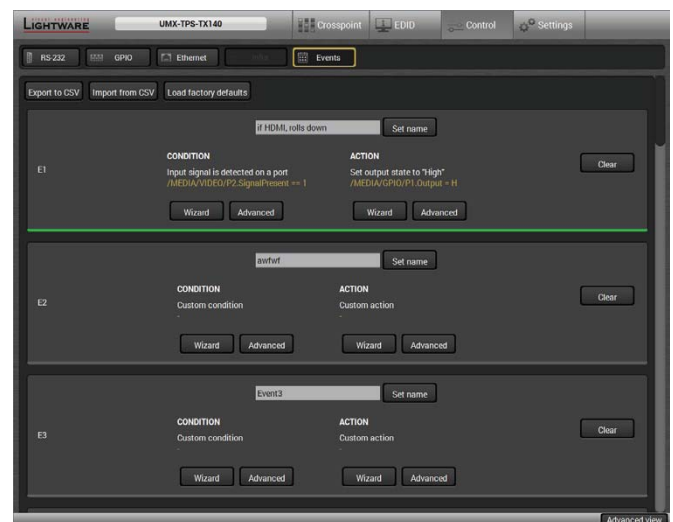

Green lines show which Event is configured and active, the rest stay grey

Event Manager example A

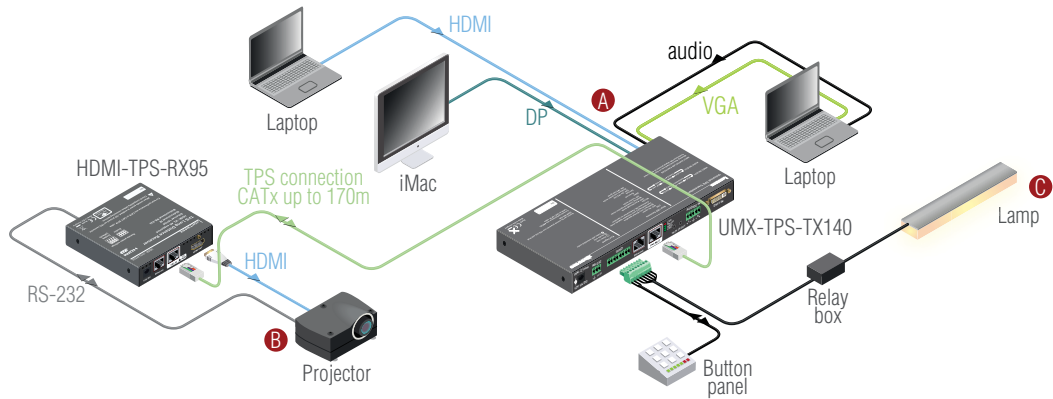

Condition	Action
<p>Press button panel</p>	<p>A Input select</p>
	<p>B Projector switch on</p>
	<p>C Lamp switch off</p>

With a connected button panel through the GPIO port the UMX-TPS-TX140 can be controlled from a remote location, input switching is available even if the transmitter mounted underdesk. In the example above there are three actions followed by a condition. When an input selector button is pressed on the remote button panel, the input port is switched to the selected one, the lamp switches off, and the projector turns on as well.

Event Manager example B

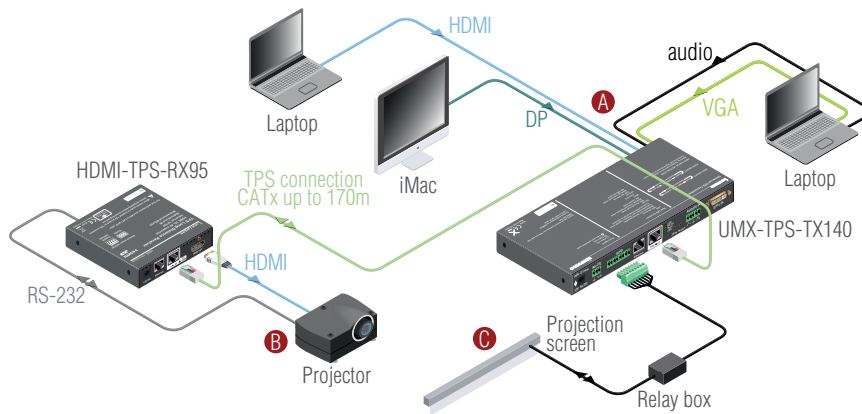



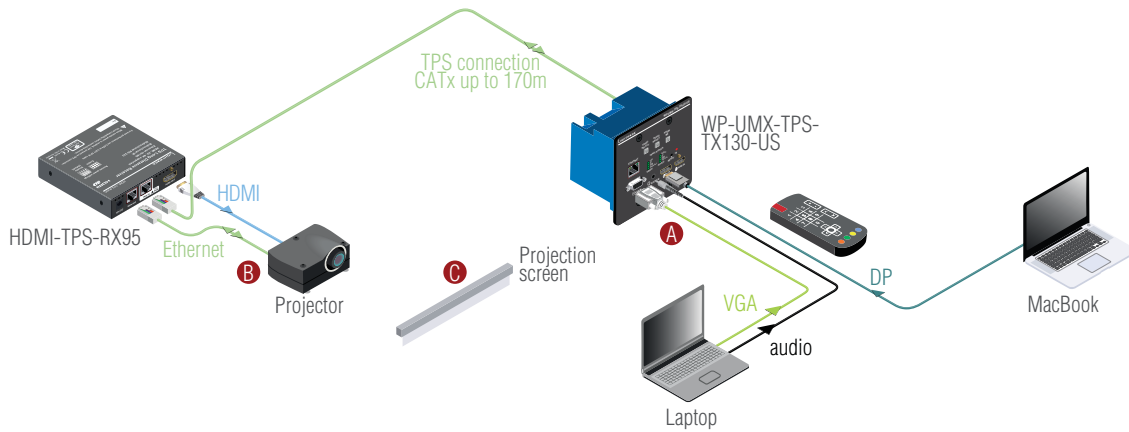

Condition	Action
	<p>A Input select</p>
	<p>B Projector switch on</p>
	<p>C Screen down</p>

The projector and the rolling screen (through the Relay box) are connected to the UMX-TPS-TX140. When the user connects a laptop through HDMI to the transmitter the connected input is selected automatically the screen goes down and the projector turns on to display the connected source.

Event Manager example C



Condition	Action
 Press remote controller	 A Input select
	 B Projector switch on
	 C Screen down

A MacBook with DisplayPort and another laptop with VGA and analog audio are connected to the WP-UMX-TPS-TX130-US wallplate which means there are two audio signals and two video signals connected. With a remote controller via IR these inputs can be switched. For example the analog audio of the Laptop can be mixed with the DisplayPort video of the MacBook. The Event Manager helps the user to assign actions like rolling the screen down and switch the projector on when the desired input is selected.

Port diagram

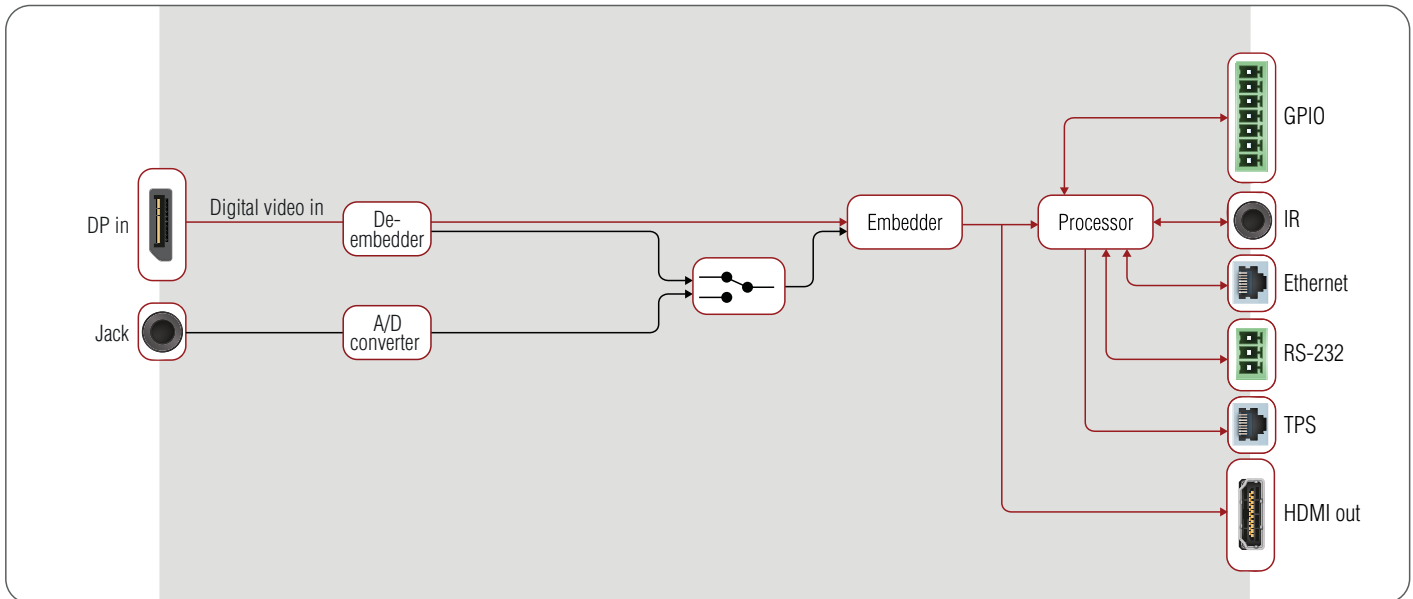

Compatibility products

- MX Series matrix frames with MX-TPS-IB or MX-TPS2-IB
- HDMI-TPS-RX90
- DVI-HDCP-TPS-RX95
- HDMI-TPS-RX95

Applications

- Small classrooms
- Conference rooms, meeting rooms
- Control rooms
- Home cinemas

Features

- 4K and UHD video
- Extends DisplayPort 1.1 + Audio + Ethernet + RS-232 + IR + GPIO over a single CAT5e...CAT7e cable up to 170 m distance*
- Audio and video connectors: DisplayPort (input), HDMI (local output), Stereo jack
- Any 3D formats supported
- Advanced EDID Manager
- Event Manager
- 10/100 Ethernet extension
- Bi-directional RS-232 and IR
- GPIO control port
- HDCP compliant, CEC
- Embeds analog audio

*Depends on cable category and quality

Specifications

Resolution:	Up to 4K UHD 3840x2160@30Hz, 1600x1200@60Hz, FullHD 1920x1080@60Hz
Digital audio formats:	Supports up to 8 channel PCM, Dolby TrueHD and DTS-HD Master Audio 7.1 formats
Input cable equalization:	Automatic max 20 m
EDID emulation:	Yes, Advanced EDID Management
EDID memory:	120 factory preset, 15 user programmable
HDCP pass-through:	Yes
RS-232 pass-through:	Yes, configurable
RS-232 (control option):	9600, 19200, 38400, 57600, 115200 Baud Rx,Tx (through CATx)(default: 57600)
Local power:	Universal power adaptor, DC 12V 2.5A
Power over TPS:	DC 48V 1 A
Power consumption:	8,5W (typ)
Enclosure:	1 mm metal
Dimensions:	221 W x 100.4 D x 26 H mm
Compliance:	CE
Warranty:	3 years

Connectors

Digital video input:	DisplayPort connector
Digital video output:	HDMI connector
Ethernet:	1 x RJ45
Control:	7 x GPIO, IR
TPS output:	1 x RJ45
Serial port:	3-pole
Power:	Locking DC connector (2.1 / 5.5 mm)

DP-TPS-TX220

Supplied accessories



PSU-12VU Universal DC adaptor (Part No: 1180 0051)
Wall power adaptor with interchangeable plug for international use.
Universal input: 100-240 V AC, 50-60 Hz, output: 12 V DC, 2.5 A



IR emitter and IR eye (Part No: 1374 0003 TX, 1374 0002 RX)
IR emitter is supplied with TPS-TX, IR eye is supplied with TPS-RX units. Needed for IR extension.

Optional accessories



Under desk mounting kit double (Part No: 5240 0276)
The UD-kit double makes it easy to mount multiple devices on any flat surface (e.g. furniture).



Rack shelf (Part No: 5240 0269)
1U high rack shelf provides mounting holes for fastening four quarter-rack sized units. Pocket sized devices can also be fastened on the shelf.